



**The Searchline Excel is  
the World's best selling  
infrared open path  
gas detector**

# Searchline Excel



## Applications include

- Offshore platforms & vessels (FPSO's)
- Downstream chemical processing plants
- Gas transport and pipelines
- Large storage areas & buildings
- Perimeter detection

## Features and Benefits

- Double band pass filters that fully compensate for all types of fog, rain and/mist interference
- 100% Solar Immune
- Correct operation under partial obscuration conditions
- High vibration resilience
- Radially symmetrical and bonded window heating delivers good low temperature performance
- Coaxial optics delivers best in class performance and resilience to partial obscuration
- Fully temperature compensated solid state detectors
- Low power consumption in all conditions
- Simple 'lock on' alignment tool
- No extra 'software alignment' required
- Higher power and more robust design telescope
- Optional Modbus RS485 multi drop output
- FM hazardous area and performance approved

**The Searchline Excel is the World's best selling infrared open path gas detector with over 25,000 units installed in challenging applications throughout industry. From the Arctic Circle to middle eastern deserts, customers have repeatedly selected the Searchline Excel as their preferred choice.**

## Product Evolution

Honeywell Analytics pioneered the original design of open path infrared flammable gas detectors with the introduction of the original Searchline back in 1987. Since then we have continued to work in conjunction with major international oil and gas companies to fully understand the demanding application requirements of these systems.

In 1998 we introduced Searchline Excel which has become the industry standard for open path gas detection by meeting and exceeding all customer driven demands.

With continuous improvement and the highest quality manufacturing and control processes, Honeywell Analytics Searchline Excel Open Path flammable gas detector provides best in class gas detection. Excel is often the chosen primary flammable gas detector in conjunction with Searchpoint Optima Plus as complimenting flammable point detection.

## Why open path gas detection?

Open path detectors complement the use of individual point detectors and offer many significant benefits including:

- Reliable flammable gas detection, proven in use
- Wider area coverage - most likely to pick up any leak
- Very high speed of response
- Failsafe - no unrevealed failure modes
  - no possibility of blocked gas path to detector
- Detector location not as critical
- Indicates size of hazard
- Simple set up and commission
- Replaces multiple point devices



**Gas leak missed by point detectors but picked up by Open Path Detector**

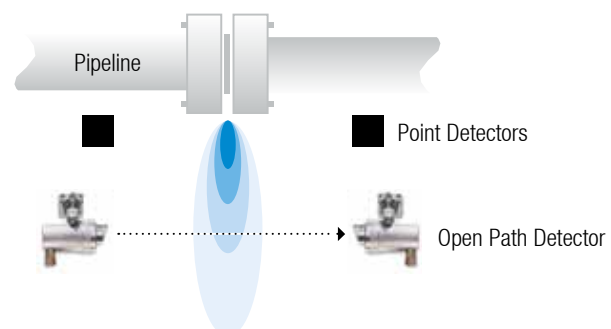

# Searchline Excel



## The Difference

The patented optical design used in Searchline Excel has proven itself as the only solution available that fully addresses all the challenges of open path flammable gas detection. Unlike some competitive devices, it does not try to hide fundamental design inadequacy with the use of software

masks that can compromise the unit's ability to detect gas. Searchline Excel employs a patented double band pass filter that fully compensates for all types of fog and / or rain, thereby allowing it to continue to operate accurately and reliably in all climatic conditions.

## Different fog types scatter/absorb differently

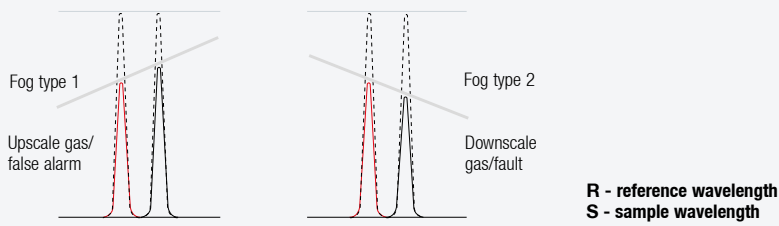

## The solution... double band pass filter

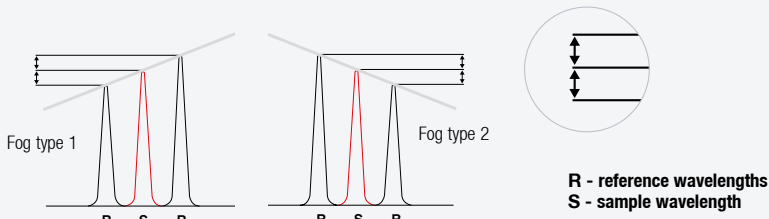

The differential scatter and absorption has a linear effect with respect to the reference wavelengths. The output from the reference

detector is the average between the reference bands and will be exactly the same as the sample wavelength.

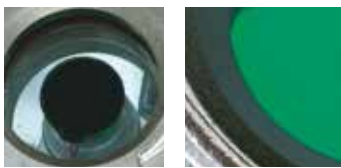

Radially symmetrical heating elements bonded to transmitter and receiver windows.

The unique **coaxial design of the optics** also means that Searchline Excel is also the only open path gas detector that can operate correctly under partial obscuration conditions without the possibility of generating a false alarm.

Non-coaxial instruments potentially suffer from differential attenuation that can lead to false alarms.



Searchline Excel was the first open path gas detector in the world to have achieved performance approval by FM.

Products or services that meet FM Approvals' rigorous testing standards may bear the FM APPROVED mark, a visual symbol of excellence that is widely recognised and respected. This "Mark of Excellence" tells customers that a company's product conforms to the highest standards and will continue to meet those standards.

### Additional FM tests

With its patented double band pass filter and unique coaxial optical design, Searchline Excel was the first open path gas detector that fully addresses the issues of performance under partial obscuration and fog/mist conditions. As these elements were not covered in the FM standard, our optical engineers worked alongside FM to develop and approve Searchline Excel to a new set of simulated fog/mist and partial obscuration tests.



# Searchline Excel



**The fundamental design of Searchline Excel has remained the same since its original launch and it continues to lead the field. Other manufacturers have tried unsuccessfully to develop comparable instruments but none have the experience or technology that is utilised in Searchline Excel.**

## Sample and reference detector alignment

- Reduced sensitivity to alignment
- Guaranteed performance
- Reduced sensitivity to partial obscuration

## Intuitive hand-held software

- Simple confirmation of alignment
- Visual indication of target and current signal levels
- Compatible with existing systems

## Accurate alignment tools

- Simple to use, accurate alignment tools
- High-power telescope
- Easier to align with greater zoom and magnification
- Robust shock resistant design

Having introduced open path flammable gas detection built upon the excellence of the Searchpoint Optima Plus optimal point gas detectors, Honeywell Analytics has continued to develop the Searchline Excel system.

This open path flammable gas detector has become the standard within the oil and gas and petrochemical industries, meeting the exacting demands of our customers.

The addition of the XNX Universal Transmitter provides local display and enhanced interfacing options such as relays and modern digital communications including HART®, Modbus and Foundation Fieldbus™.



## True Alignment System

A good installation is key to obtaining the best performance from an open path gas detection system. Optimum alignment of the transmitter and receiver will ensure the best performance of the system in the harshest climatic conditions.

A visual check of the path using a telescope is required to ensure that there are no physical obstructions in the beam. With the True Alignment System used on Searchline Excel this alignment is so accurate that the requirement for further adjustment using a software based alignment tool is eliminated.



## Unique, proven telescope mounting mechanism

- Simple engagement and locking mechanism
- 3 point mounting datum ensures true alignment
- Sight can be angled to most convenient position
- So accurate that further 'software guided' adjustments not required



# Solar Immune



**Searchline Excel is totally immune to interference from sunlight or any other sources of radiation such as flare stacks, arc welding or lightning.**

This is achieved by using a xenon flash lamp that is actually brighter than the sun at the infrared detection wavelengths and solid state detectors with a wide dynamic range.

The lamp is also modulated to have a unique pulse duration and shape. The receiver then uses high speed digital signal processing to validate that all the signals received have this unique signature and rejects any extraneous signals.

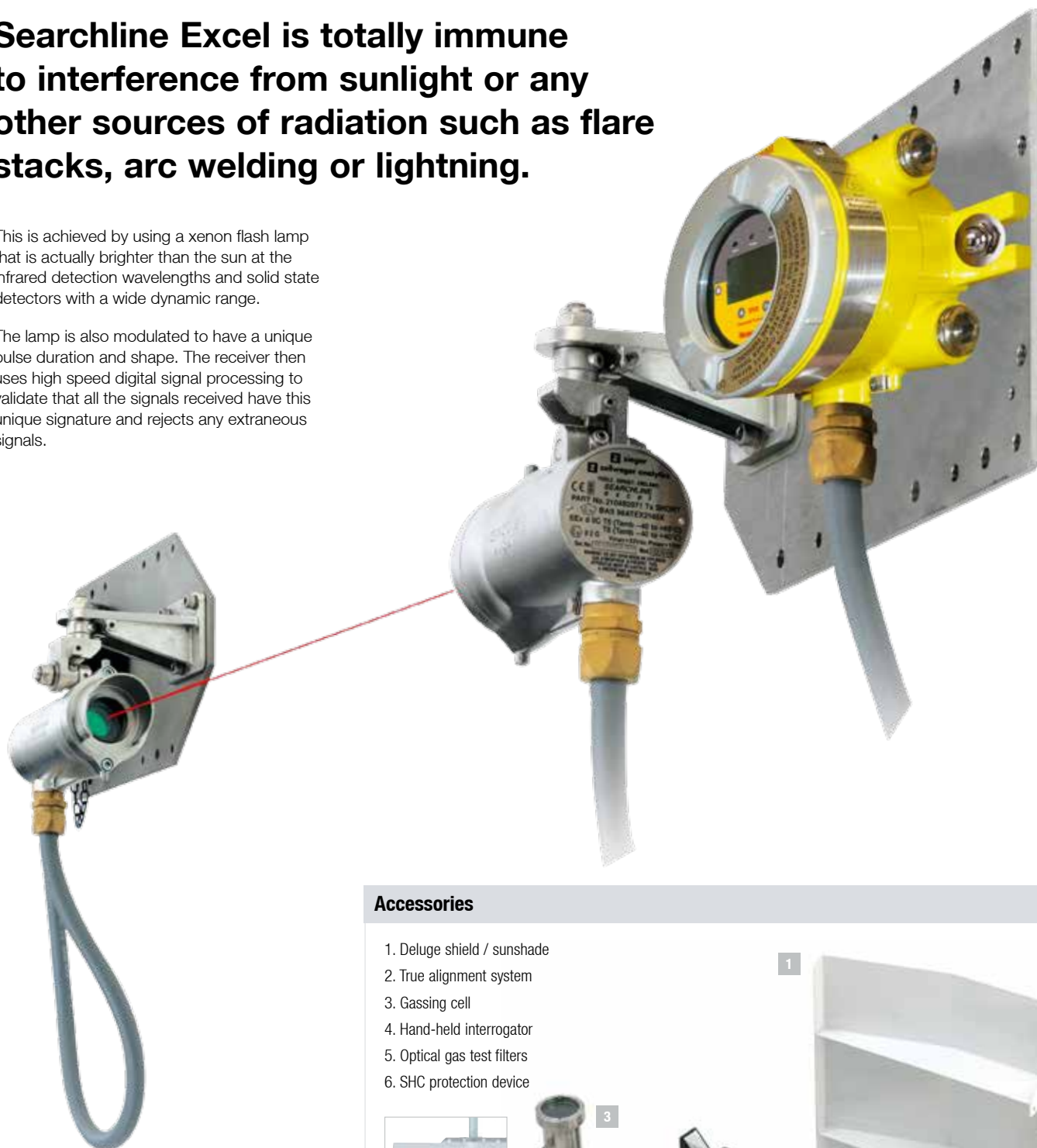

## Accessories

1. Deluge shield / sunshade
2. True alignment system
3. Gassing cell
4. Hand-held interrogator
5. Optical gas test filters
6. SHC protection device



# Modbus Digital Output



## Modbus digital output - know before you go!

Searchline Excel is also available as a kit with the XNX Universal Transmitter, featuring both a local HART® port and HART® over 4 to 20mA as standard. These solutions allow configuration of the Searchline Excel through the XNX user interface or using a compatible HART® hand-held interrogator 1 device. Alternatively, an intrusive connection

to the Searchline Excel using an SHC-1 hand-held interrogator together with an SHC-1 protection device module can be made in applications that allow such operations.

The multi drop Modbus capability can enable significant savings in installation and cabling costs. A single comms cable can be run between up to 32 detectors instead of the

usual 'single run' required for each detector. Additionally, the 2 way digital communication protocol allows configuration, warning and fault diagnosis information to be communicated back to the control room. This reduces servicing and maintenance costs as the operator can diagnose the state of any individual unit before deciding to send anyone into the field.

### Installation options

#### Options



XNX Universal Transmitter



DX100 (M)  
UL/CSA/FM approved



OTB122 Junction box

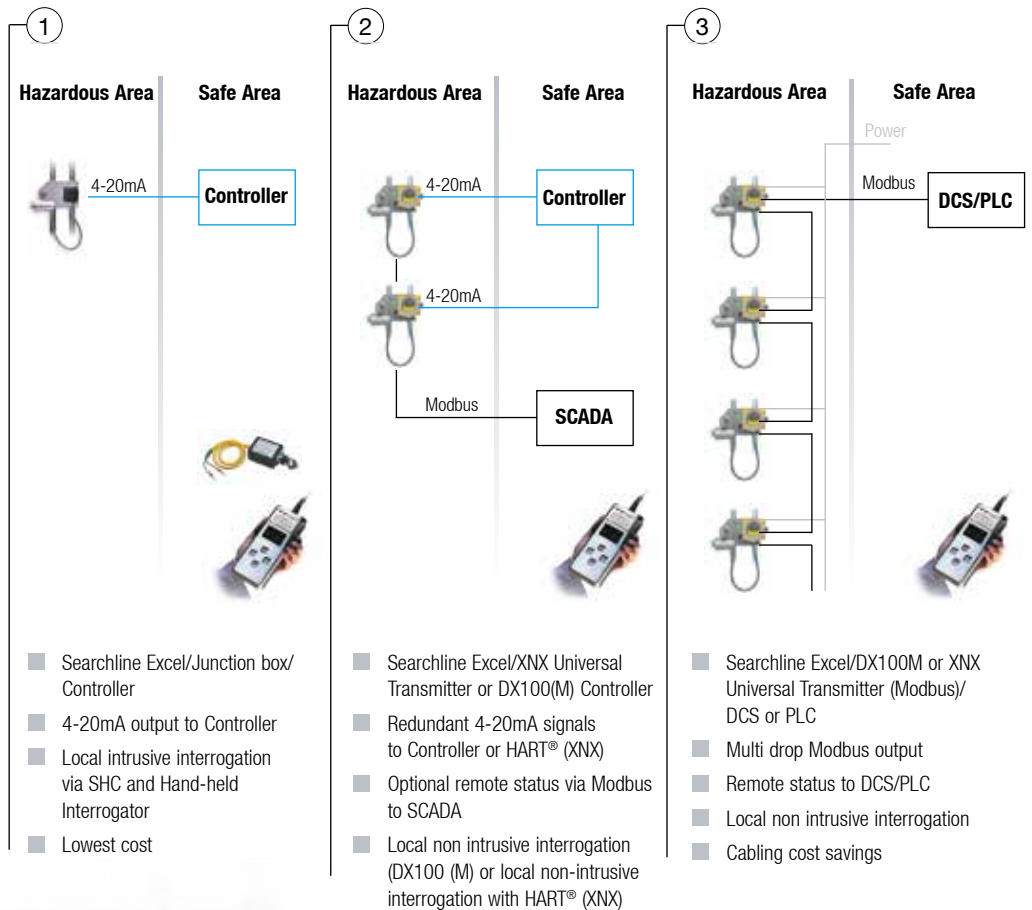

# Technical Summary

## Searchline Excel



Specification	
<b>Available Gases</b>	Methane, Ethane, Propane, Butane, Pentane, Ethylene, Propylene, Butadiene
<b>Range</b>	0 to 5 LEL.m
<b>Recommended Alarm Settings</b>	(Low) 1.0 LEL.m; (high) 3.0 LEL.m
<b>Path Lengths</b>	Short Range 5m to 40m (15ft to 130ft.), Medium Range 40m to 120m (130ft to 390ft.) and Long Range 120m to 200m (390ft to 650ft.)
<b>Speed of Response</b>	T90 less than 3 seconds. (under normal operating conditions)
<b>Output Signal</b>	4-20mA (maximum loop resistance 600 ohms; source & sink available) and RS485 21mA Over range 4-20mA Normal operation (0 to 5 LEL.m) 3mA <sup>(1)</sup> Dirty optics 2.5mA <sup>(1)</sup> Beam blocked 2mA <sup>(1)</sup> 0mA Fault
<b>Digital Output</b>	Modbus RS485 multi drop. Using DX100 (M) or XNX Universal Transmitter with Modbus option
<b>Operating Temperature</b>	-40°C to +65°C (-40°F to 150°F)
<b>Operating Humidity</b>	0 to 99% RH (non-condensing)
<b>Operating Pressure</b>	91.5 to 105.5 KPa (915 to 1055 mbar) (non-compensated)
<b>Warm-up Time</b>	Less than 5 minutes (operational), or less than 1 hour (fully stabilised)
<b>Power Supply</b>	18V to 32VDC
<b>Power Consumption</b>	Short Range Tx: 3.5W / 5.0W *maximum. Medium and Long Range Tx: 10W / 13W* maximum. Rx: 8W maximum.
<b>Enclosure Material</b>	316 stainless steel
<b>Weight (inc. mounting bracket)</b>	Short Range TX: 3.5kg Medium and Long Range TX: 7kg RX: 3.5kg
<b>Vibration</b>	2 to 60Hz, max ptp amplitude 1mm.
<b>Misalignment Tolerance</b>	Short Range ±0.5° (±~35cm at 40m). Medium Range ±0.5° (±~104cm at 120m). Long Range ±0.5° (±~170cm at 200m)
<b>EMC Standards</b>	EN50270
<b>Performance Approval</b>	FM performance approved
<b>Safety Approval</b>	<p><b>ATEX</b> Transmitter:                      Ⓜ II 2 G Ex d op is IIC T5 (Tamb -40°C to +65°C) Gb                      Ⓜ II 2 G Ex d op is IIC T6 (Tamb -40°C to +40°C) Gb</p> <p>Receiver:                      II 2 G Ex d IIC T5 (Tamb -40°C to +65°C) Gb                      II 2 G Ex d IIC T6 (Tamb -40°C to +40°C) Gb</p> <p><b>IECEX</b> Transmitter:                      Ex d op is IIC T5 (Tamb =-40°C to +65°C) Gb                      Ex d op is IIC T6 (Tamb =-40°C to +40°C) Gb</p> <p>Receiver:                      Ex d IIC T5 (Tamb -40°C to +65°C) Gb                      Ex d IIC T6 (Tamb -40°C to +40°C) Gb</p> <p><b>UL:</b> Class 1 Groups B, C, D and Class 1 Zone 1 AEx d IIB + Hydrogen (Amb -40°C to +65°C)  <b>CSA:</b> Class 1 Div 1 groups B, C, D, T5 and Exd IIC T5 (Amb -40°C to +65°C)  <b>FM:</b> Class 1 Div 1 groups B, C, D &amp; T5 (T<sub>amb</sub> -40 to +65°C)  <b>Other:</b> GOST                      Independently assessed to IEC61508</p>
<b>IP Rating</b>	IP66 and IP67

<sup>(1)</sup> User programmable.  
 \* Turboheating activated (standard feature; user selectable). This is recommended for the most severe weather conditions.

Tx / Rx = 80mm

Tx / Rx = 185mm

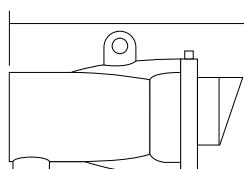
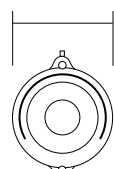

Tx = 137mm  
Rx = 80mm

Tx = 235mm Rx = 185mm

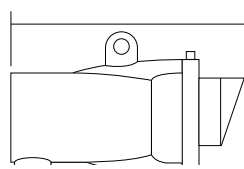

Short Range 5m to 40m (15ft to 130ft)

Medium Range 40m to 120m (130ft to 390ft) and Long Range 120m to 200m (390ft to 650ft)

# Honeywell Analytics Gas Detection



Honeywell Analytics is able to provide gas detection solutions to meet the requirements of all applications and industries. Contact us in the following ways:

## Headquarters

### Europe, Middle East, Africa

Life Safety Distribution AG

Javastrasse 2

8604 Hegnau

Switzerland

Tel: +41 (0)44 943 4300

Fax: +41 (0)44 943 4398

gasdetection@honeywell.com

### Customer Service:

Tel: +800 333 222 44 (Freephone number)

Tel: +41 44 943 4380 (Alternative number)

Fax: +800 333 222 55

Middle East Tel: +971 4 450 5800 (Fixed Gas Detection)

Middle East Tel: +971 4 450 5852 (Portable Gas Detection)

### Americas

Honeywell Analytics Distribution Inc.

405 Barclay Blvd.

Lincolnshire, IL 60069

USA

Tel: +1 847 955 8200

Toll free: +1 800 538 0363

Fax: +1 847 955 8210

detectgas@honeywell.com

### Asia Pacific

Honeywell Analytics

Asia Pacific

#701 Kolon Science Valley (1)

43 Digital-Ro 34-Gil, Guro-Gu

Seoul 152-729

Korea

Tel: +82 (0) 2 6909 0300

Fax: +82 (0) 2 2025 0388

India Tel: +91 124 4752700

analytics.ap@honeywell.com

## Technical Support Centres

Honeywell Analytics Ltd.

4 Stinsford Road

Nuffield Industrial Estate

Poole, Dorset, BH17 0RZ

United Kingdom

Tel: +44 (0) 1202 645 544

Fax: +44 (0) 1202 645 555

Honeywell Analytics

ZAC Athélia 4 - 375 avenue du Mistral

Bât B, Espace Mistral

13600 La Ciotat

France

Tel: +33 (0) 4 42 98 17 75

Fax: +33 (0) 4 42 71 97 05

Honeywell Analytics

Elsenheimerstrasse 43

80687 München

Germany

Tel: +49 89 791 92 20

Fax: +49 89 791 92 43

Honeywell Analytics

P.O. Box-45595

6th Street

Musaffah Industrial Area

Abu Dhabi

UAE

Tel: +971 2 554 6672

Fax: +971 2 554 6672

EMEA: HAexpert@honeywell.com

US: ha.us.service@honeywell.com

AP: ha.ap.service@honeywell.com

[www.honeywellanalytics.com](http://www.honeywellanalytics.com)

[www.raesystems.com](http://www.raesystems.com)

**Honeywell Analytics**  
Experts in Gas Detection

**BWF**  
Technologies  
by Honeywell

**RAE**  
SYSTEMS  
by Honeywell

### Please Note:

While every effort has been made to ensure accuracy in this publication, no responsibility can be accepted for errors or omissions. Data may change, as well as legislation, and you are strongly advised to obtain copies of the most recently issued regulations, standards, and guidelines. This publication is not intended to form the basis of a contract.

11256\_H\_Searchline Excel\_IR\_DS0282\_V8\_EMEA

02/15

© 2015 Honeywell Analytics

**Honeywell**



